

TOX[®]-ElectricPowerDrive Type EXe-F

Data sheet 40.65
2023/06



TOX[®]-ElectricPowerDrive servo drive

Type EXe-F, 5 – 100 kN with planetary roller screw

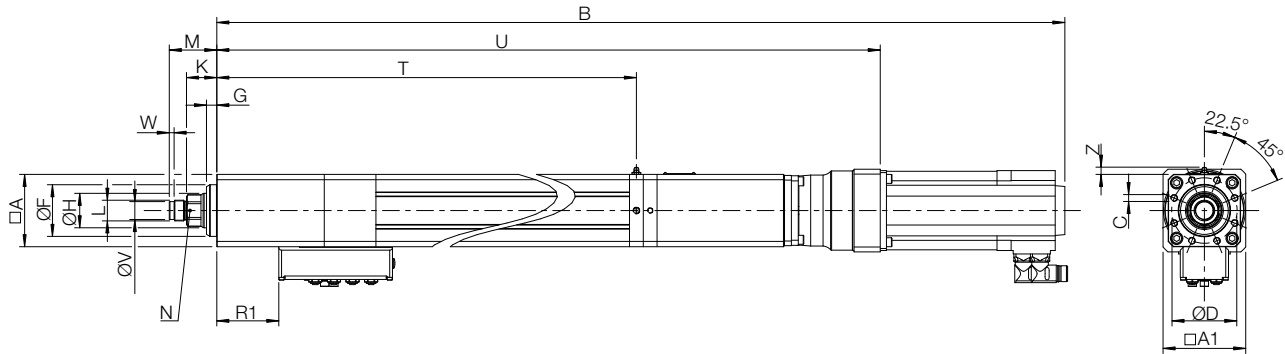

Dimensions and weights

Preferred series (short delivery time)

Type	Stroke length mm	Max. nominal force kN	Weight kg
EXe-F 005.XXX.150	150	5	23
EXe-F 005.XXX.300	300	5	25
EXe-F 010.XXX.150	150	10	38
EXe-F 010.XXX.300	300	10	40
EXe-F 030.XXX.150	150	30	67
EXe-F 030.XXX.300	300	30	71
EXe-F 060.XXX.150	150	60	115
EXe-F 060.XXX.300	300	60	120
EXe-F 100.XXX.150	150	100	171
EXe-F 100.XXX.300	300	100	180

Type	A	A1	B	C	D	F ₇₇	G	H	K ¹⁾	L	M ¹⁾	N ¹⁾	R1	T	U	V ₉₆	W	Z
EXe-F 005.XXX.150	70	90	883	8x M6x12	60	50	10	30	28	M12x1.5	40	27	12	497	620	-	-	10
EXe-F 005.XXX.300	70	90	1033	8x M6x12	60	50	10	30	28	M12x1.5	40	27	12	647	770	-	-	10
EXe-F 010.XXX.150	90	90	1120	8x M8x16	80	65	10	40	26	M22x2	46	36	53	585	858	18	7	10
EXe-F 010.XXX.300	90	90	1270	8x M8x16	80	65	10	40	26	M22x2	46	36	53	735	1008	18	7	10
EXe-F 030.XXX.150	105	120	1284	8x M10x20	95	75	15	50	44	M30x2	69	41	90	662	1016	26	7	10
EXe-F 030.XXX.300	105	120	1434	8x M10x20	95	75	15	50	44	M30x2	69	41	90	812	1166	26	7	10
EXe-F 060.XXX.150	130	150	1422	8x M12x24	115	90	17	60	42	M30x2	67	55	115	702	1140	26	7	10
EXe-F 060.XXX.300	130	150	1572	8x M12x24	115	90	17	60	42	M30x2	67	55	115	852	1290	26	7	10
EXe-F 100.XXX.150	160	150	1562	8x M16x32	135	105	17	75	42	M39x2	77	65	155	789	1240	-	-	10
EXe-F 100.XXX.300	160	150	1712	8x M16x32	135	105	17	75	42	M39x2	77	65	155	939	1390	-	-	10

¹⁾ Dimension refers to zero position of drive. Reference position = zero position -3mm.

Dimensions in mm

Specifications EXe-F	005	010	030	060	100
Mechanical					
Nominal pressing force	5 kN	10 kN	30 kN	60 kN	100 kN
Nominal pulling force	3 kN	3 kN	8 kN	17 kN	30 kN
Max. speed ¹⁾	800 mm/s	550 mm/s	500 mm/s	350 mm/s	300 mm/s
Repeatability ²⁾	0.01 mm				
Max. tool weight without brake ⁵⁾	5 kg	10 kg	15 kg	25 kg	35 kg
with motor holding brake ⁶⁾	25 kg	125 kg	250 kg	500 kg	600 kg
Sensors					
Force transducer measuring range ³⁾	0.05 – 5 kN	0.1 – 10 kN	0.3 – 30 kN	0.6 – 60 kN	1 – 100 kN
Accuracy	≤ ±0.5 % of nominal pressing force				
Resolver	■	■	■	■	■
Resolution (theoretically)	0.00593 mm	0.00370 mm	0.00370 mm	0.00296 mm	0.00296 mm
Electrical					
Protection class ⁴⁾	IP 54				
Mains supply	see data sheet 40.15 System & Components				
Climatic conditions	+ 10° to + 40° C, from 40° C performance loss, max. 55° C; air moisture < 75 %, without condensation				

¹⁾ Special versions on request

²⁾ In thermal transient condition

³⁾ Recommended operating range 1 – 100 %

⁴⁾ Optional: Protection class IP 65

⁵⁾ For higher weights, the tool can sink in de-energized condition

⁶⁾ Higher tool weights on request

A wide range of accessories is available for the servo drive type EXe-F (see data sheet 40.95, TOX®-ElectricPowerDrive Accessories).

Ordering example

EXe-F 005.XXX.150

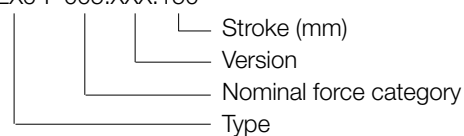

Version

- 003 Basic version
- 006 Motor holding brake
- 007 Includes holding time min 10s at min. 80% of nominal pressing force
- 053 Includes protection class IP65
- 302 Includes working piston with threaded holes on piston end

Further versions are available upon request!

TOX[®]-EdgeUnit

TOX[®]-EdgeUnit is the decentralized intelligence for each TOX[®]-ElectricPowerDrive

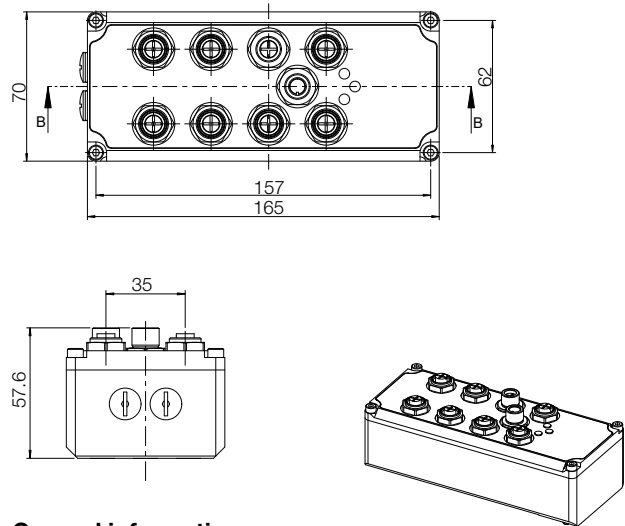
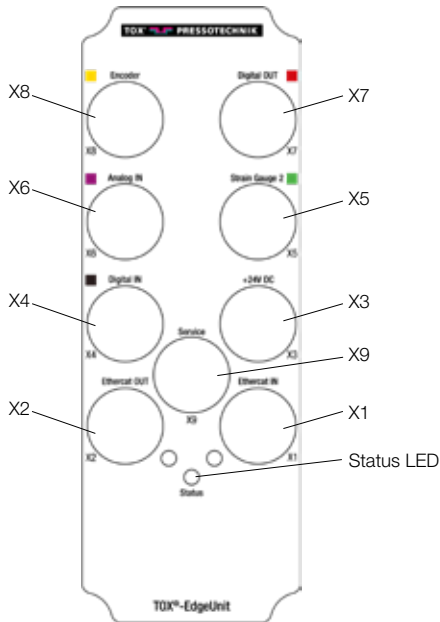

General information:

- Ambient temperature: 0 ... 50°C
- IP protection: IP 65 (plug closed)
- Housing: aluminum
- Status LED shows different states of the TOX[®]-EdgeUnit
- Integrated memory

Technical data/interfaces

X1 ■	Ethercat IN, incl. status LED
Pin assignment	M12 4-pin Bushing, D-coded
X2 ■	Ethercat OUT, incl. status LED
Pin assignment	M12 4-pin Bushing, D-coded
X3	Power supply
Voltage	+ 24VDC (18 ... 28 VDC)
Current draw	US1 <0,25A (without loads at Pin1, X4-7) US2 ~0A (without outputs at X7)
US1 US2	Logic voltage + sensors Output voltage (not electrically isolated)
Pin assignment	M12 5-pin, plug A-coded
X4 ■	Digital IN
Digital IN 1 / Digital IN 2	24VDC
Logic level 0 (LOW)	0V ... 10V
Logic level 1 (HIGH)	16V ... 28V
Input current	max. 2 mA (at 24V)
Pin assignment	M12 5-pin bushing, A-coded
X5* ■	Strain Gauge 2
Measuring range	1.157 mV/V – 3,25 mV/V (intensifier adjustable)
Voltage VDC	5V
Shunt resistor	typ. 700 Ω
Resolution	16 Bit
Pin assignment	M12 5-pin bushing, A-coded

X6* ■	Analog IN
Analog IN 1	-10 ... 10VDC, 16 bit
Analog IN 2	0 ... 10VDC, 12 bit
Pin assignment	M12 5-pin bushing, A-coded
X7 ■	Digital OUT
Digital OUT 0 / Digital OUT 1	24VDC, US2
Output current	max. 2 A (per channel) / overcurrent and short-circuit proof
Pin assignment	M12 5-pin bushing, A-coded
X8* ■	Encoder
Pin assignment	M12 8-pin bushing, A-coded
X9	Service pin
Pin assignment	M12 8-pin Plug, A-coded

*Compatible sensor types available on request

M12 pin assignment

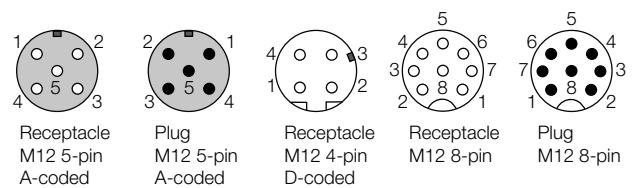

Pin assignments

EdgeUnit

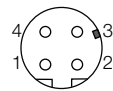
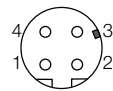
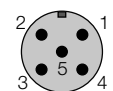
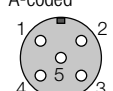
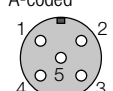
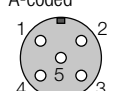
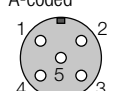
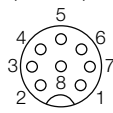
Version	Designation	Description
X1 Receptacle 4-pin, D-coded 	EtherCat In	Pin 1 = TD+ Pin 2 = RD+ Pin 3 = TD- Pin 4 = RD-
X2 	EtherCat Out	Pin 1 = TD+ Pin 2 = RD+ Pin 3 = TD- Pin 4 = RD-
X3 Plug 5-pin, A-coded 	Power	Pin 1 = 24V US2 Pin 2 = GND US2 Pin 3 = 24V US1 Pin 4 = GND US1 Pin 5 = PE GND US1 = GND US2 = GNO
X4 Receptacle 5-pin, A-coded 	Digital In	Pin 1 = 24V US1 Pin 2 = DIN2 24V Pin 3 = GND Pin 4 = DIN1 24V Pin 5 = PE
X5 	Strain Gauge 2	Pin 1 = Strain Gauge Sig (neg) Pin 2 = 5V Strain Gauge Ref Pin 3 = GND Pin 4 = Strain Gauge Sig (pos) Pin 5 = -
X6 	Analog In	Pin 1 = 24V US1 Pin 2 = AIN2 0 ... 10V Pin 3 = GND Pin 4 = AIN1 -10 ... 10V Pin 5 = PE
X7 	Digital Out	Pin 1 = 24V US1 Pin 2 = DOUT1 24V US2 (2A) Pin 3 = GND Pin 4 = DOUT0 24V US2 (2A) Pin 5 = PE
X8 Receptacle 8-pin 	Encoder	Pin 1 = 5V Pin 2 = APR Pin 3 = ANR Pin 4 = BPR Pin 5 = BNR Pin 6 = CPR Pin 7 = CNR Pin 8 = GND

Motor/Motor holding brake (optional)

For TOX®-ElectricPowerDrive EXe-F 005, 010, 030

Pin	Designation	Description	Plug
1	BD1	Immobilisation brake DC +/-AC	
2	BD2	Immobilisation brake DC +/-AC	
PE	PE	Protective conductor	
4	U	Power leg U	
5	V	Power leg V	
6	W	Power leg W	

Type: Intercontec ICN-M23, 6-pin

For TOX®-ElectricPowerDrive EXe-F 060, 100

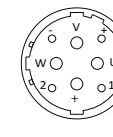
Pin	Designation	Description	Plug
U	U	Power leg U	
+	BD1	Immobilisation brake +	
-	BD1	Immobilisation brake -	
W	W	Power leg W	
V	V	Power leg V	
PE	PE	Protective conductor	
1		Not occupied	
2		Not occupied	

Type: Intercontec ICN-M40, 8-pin

Resolver

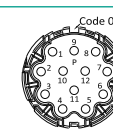
Pin	Designation	Description	Stecker
1	+Ref	Transformer windings	
2	-Ref	Transformer windings	
3	+VCC ETS	Not assigned	
4	+COS	Stator winding Cosinus	
5	-COS		
6	+SIN	Stator windings Sinus	
7	-SIN		
8		Not assigned	
9			
10	Shield	Housing shield of transmitter	
11	+	Temperature monitoring: PT1000	
12	-	Temperature monitoring: PT1000	

Type: Intercontec ICN-M23, 12-pin

Lifetime L10

The lifetime L10 is a complex calculation. The following factors influence the lifetime L10, in some cases considerably:

- Rate of force application
- Powerstroke
- Punching impact
- Application
- Revolutions per minute

Schematic illustration of the lifetime L10

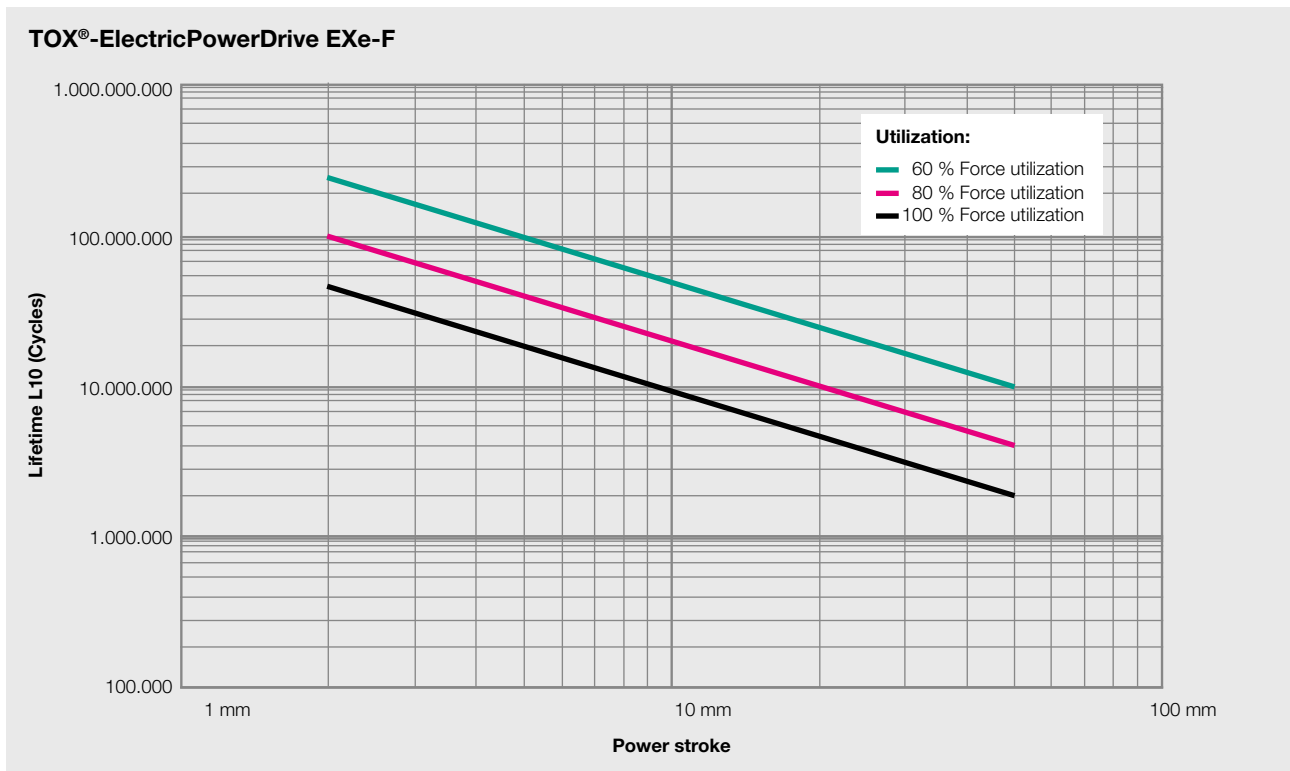

We are happy to carry out the lifetime calculation for your application. Just ask us!